

ODYSSEY[®] BATTERY

ODP-AGM27M (ELT-AGM27M)

Technical Data Sheet

Battery Type

AGM with Thin Plate Pure Lead (TPPL). Advanced dual-purpose battery for engine start and deep-cycle use

Power & Performance

Voltage	12V
Capacity (20-hour rate)	85Ah
Capacity (10-hour rate)	79Ah
Cold Cranking Amps (CCA, SAE J537)	850A
PHCA - 5-second pulse current	1500A
HCA	1150A
MCA	975A
Reserve capacity	182 mins
Short circuit current (using IEC method)	2400A
Internal resistance at 20°C (using IEC method)	3.8 mΩ

Dimensions & Weight

Length	318 mm
Width	173 mm
Height (to top of terminals)	224 mm
Height Container	208 mm
Weight	27.1 kg

Temperature

Operating Temperature Range	-40°C to +60°C
Optimum Storage Temperature	+20°C

Accreditations

The management systems governing the manufacture of this product are ISO 9001 and ISO 14001 certified.

Charging & self-discharge

Type of charging curve	IUU
Charge voltage @ +20°C	14.4V to 14.8V
Self-discharge per month at +20°C	1.25%
Self-discharge per month at +40°C	5%

Fitting, handling & storage

Can be mounted or stored in any orientation except inverted. 2-years storage life at +20°C without charging, or until the Open Circuit Voltage (OCV) is <12.6V or <2.10Vpc, whichever occurs first. Classified as non-spillable and approved as non-hazardous cargo for ground, sea and air transportation in accordance with the requirements of IMDG (International Maritime code for dangerous Goods) and ICAO (International Civil Aviation Organisation).



Terminal Position



+

-

Terminal Type

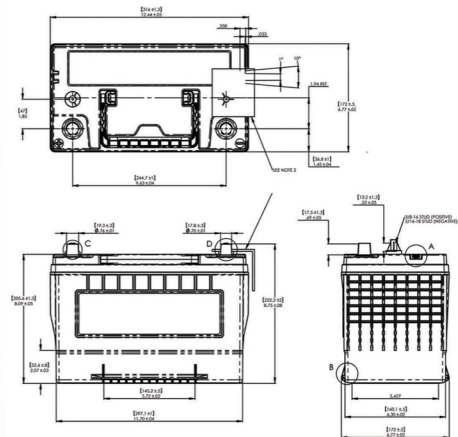
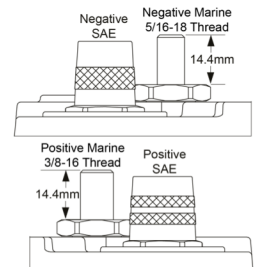

PDF Generated at <https://eu.odysseybattery.com> 17/11/2021 08:37:55
Information correct at time of exporting PDF. Please check website for updates.



EnerSys World Headquarters
2366 Bernville Road
Reading, PA 19605, USA
Tel: +1-610-208-1991 /
+1-800-538-3627

EnerSys EMEA
EH Europe GmbH
Baarerstrasse 18
6300 Zug,
Switzerland

EnerSys Asia
152 Beach Road
Gateway East Building #11-08
Singapore 189721
Tel: +65 6508 1780