

Product overview

Batteries for Trucks, Buses, Construction, Agriculture

StartPRO FG1553



Part number	FG1553
Technology	Flooded
EAN/GTIN	3661024046558
Voltage	12 V
Capacity	155 Ah
CCA	900 A
Length	513 mm
Width	223 mm
Height	223 mm
Box size	D05
Polarity	ETN 3
Terminal Type	EN taper post
Hold Down	B0
Weights (subject of variation)	40.20 kg

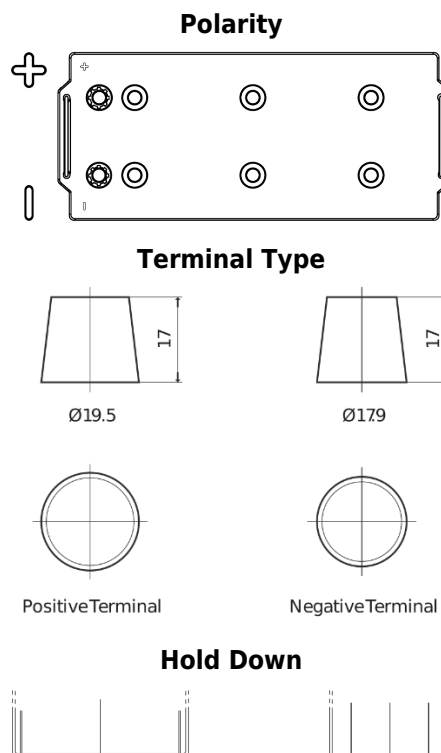

Design, features and specifications are subject to change without notice. We disclaim any representation or warranty, express or implied, concerning the data or recommendations, and in no event shall be liable for any loss or damage claimed to have arisen as a result. Some products may not be available in your local market.